

- <sup>ぶんどき</sup>分度器の中心を点アに合わせて次の角度をかきましょう。

1 230°

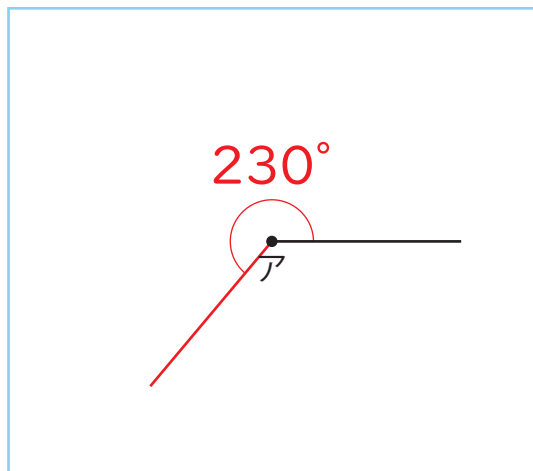

2 290°

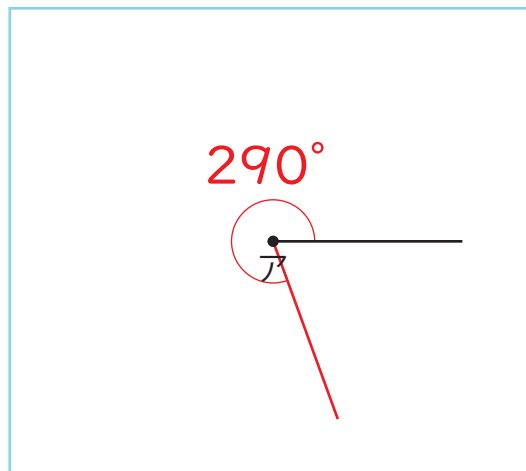

3 330°

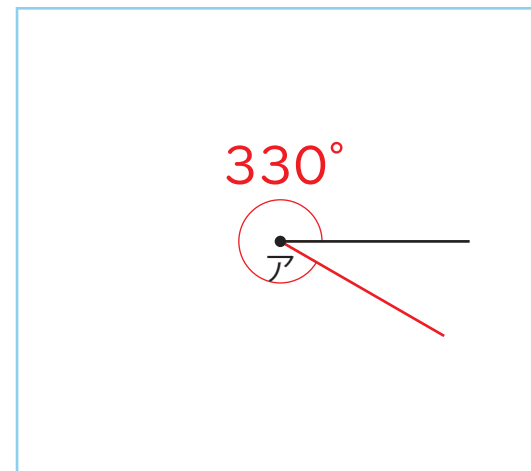

4 350°

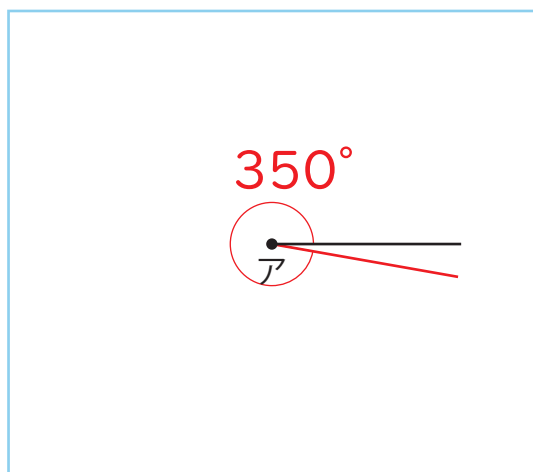

5 220°

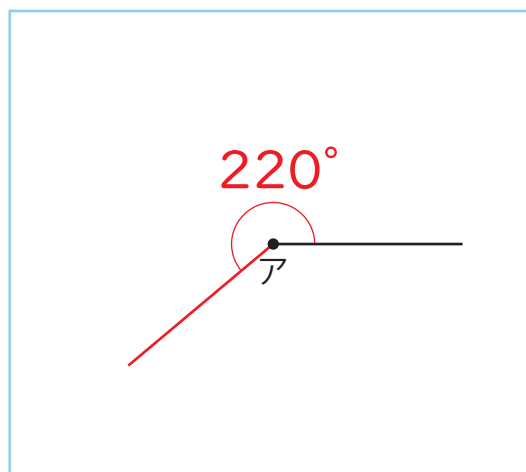

6 240°

